

GPS Clock Movement for stand-alone clocks

GU 192 / 192t V2

Robust, self-setting, modular movement for outdoor clocks up to 80 cm (with or without illumination) to display hours and minutes. Autonomous operation for more than five years with exchangeable high capacity lithium battery.

Worldwide use and time display with to-the-second accuracy thanks to GPS time reference synchronization. Calculation of local time for more than 50 selectable time zones.

Automatic daylight saving time change according to the selected time zone.

Up to three movements, model BU 192/192t, can be connected in cascade to a GU 192 V2/192t V2.

Applications:

- Street clocks
- Autonomous country clocks e.g. for stations

GU 192 V2/192t V2 - Autonomous GPS Clock Movement

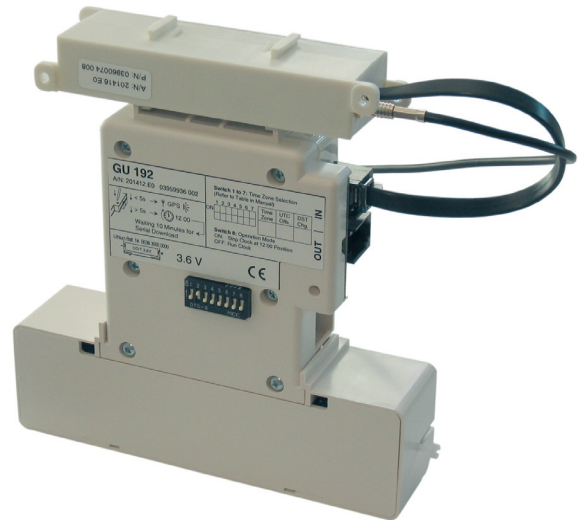
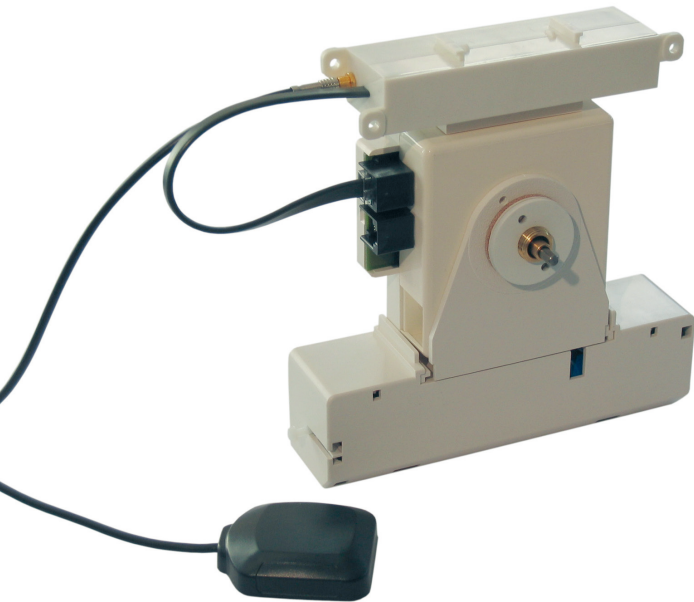

Movement with GPS receiver allows accurate, to-the-second display. GPS satellites are being used for the most precise time reference for internal quartz clock of the GU 192 V2 periodically.

With up to three slave movements the BU 192/192t can be synchronized from a GU 192 V2 in cascade connection. A replaceable lithium battery powers the movement reliably for more than 5 years.

When in operation, the movement reads time and date from GPS and sets itself automatically to the correct time.

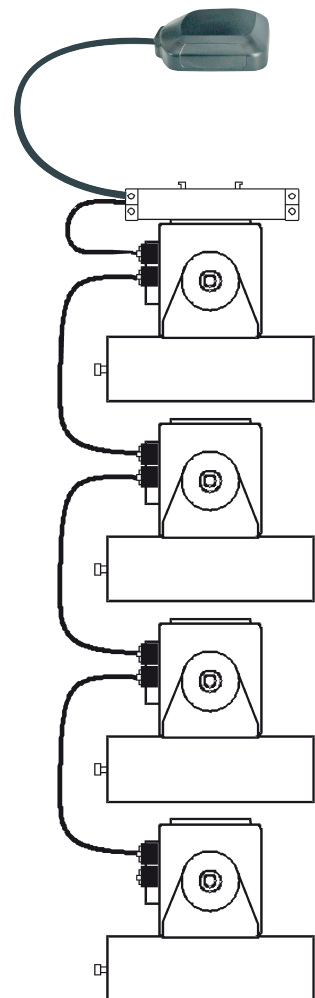
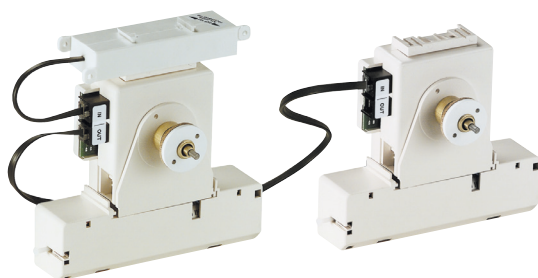

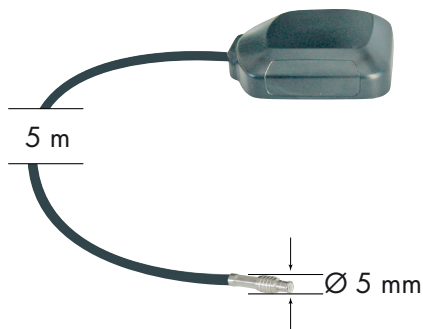
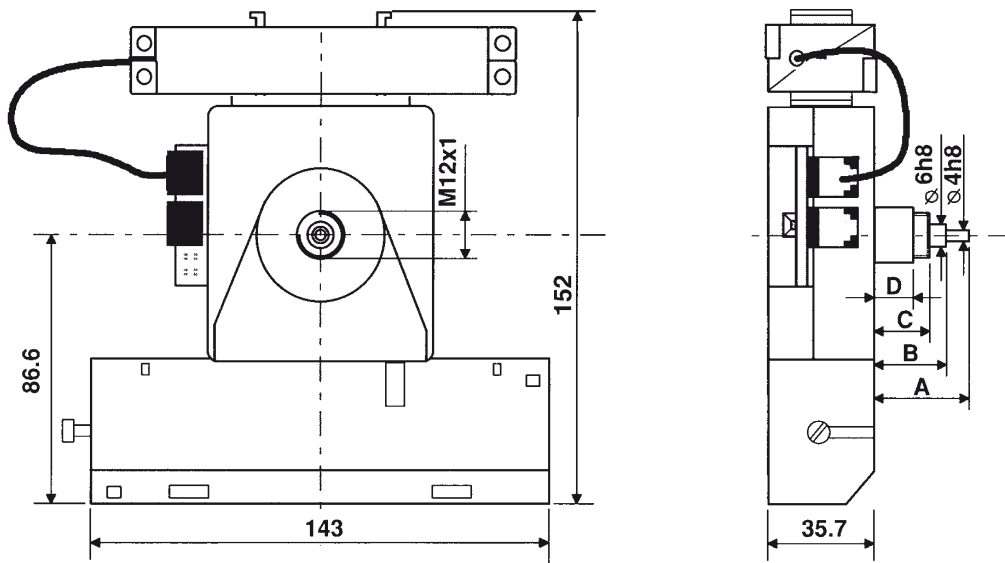

GPS magnet antenna in weather-proof casing for mounting outside the clock housing, with a clear view of the sky (zenith $\pm 60^\circ$).

GPS magnet antenna with 5 meter antenna cable L x W x H 50 x 42 x 14 mm. Antenna plug for connection to the GU 192 V2 movement.

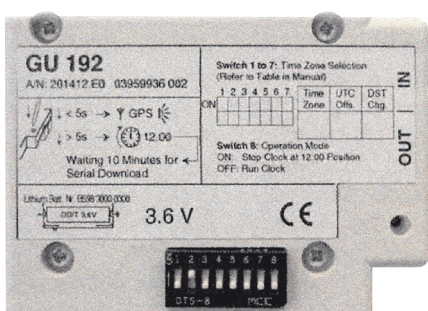

Time zone selectable by means of a DIP switches.

Calculation of the current local time for more than 50 selectable time zones, consisting of time-offset to UTC and a rule for the seasonal daylight saving time change.

Note: The time broadcasted by GPS is UTC (Universal Time Coordinated). Local time is calculated according to the selected time zone.

Example:

Local time [Berlin] = UTC + 1 hour + 1 hour during daylight saving time.

If a suitable time zone cannot be found on the list, a new time zone can be defined using a computer program and the serial interface IF 494 (option) which can then be downloaded from a PC into the movement.

Dimension table for BU.../GU...	192	192t
Shaft for minute hand A ($\varnothing 4$ mm)	18,9	34,0
Shaft for hour hand B ($\varnothing 6$ mm)	11,9	27,0
Thread for central mounting C (M12x1)	8,4	23,5
Distance tube D (mm)	-	8,0
Maximal dial thickness (mm)	5,0	8,0

GU 192 V2/192t V2 - Industrial Clock Movement

Technical Data	Item No. GU 192 V2: 120719 / GU 192t V2: 120720	
Operation modes	1 motor for minute and hour hand Normal mode: 1 step per minute Catching up mode: 2 steps per second	
Automatic setting of the hands to the correct time according to the selected time zone	✓	
Automatic daylight saving time change over according to the selected time zone	✓	
Table with > 50 time zone entries	Selectable by means of DIP switches	
Option: Download of an editable time zone entry	✓	
Reading-in of time and date from GPS	Cold start: max. 25 minutes Warm start: max. 2 minutes	
Periodic time synchronization by GPS	Once per week	
Signalization of missing GPS-reception	Movement sets hands to 12 o'clock position after approx. 1.5 months without reception	
Periodic check of the hand's position	Once every 12 hours	
Dimensions of the hands	According to DIN 41092/3 for dial diameter up to 80 cm	
Max. weight of the hands	Minute hand (balanced) 140 g, hour hand (balanced) 110 g	
Fixation	Central-nut M12 x 1 mm	
Dimensions of the movement	See dimensional drawing	
GPS receiver part	L1 frequency 1575.42 MHz, C/A Code, 12 channel	
GPS antenna	Active miniature antenna with 5 m coaxial cable, pluggable	
Accuracy (any deviation will be corrected by the weekly GPS synchronization)	0.2 seconds per day, at 0°C to 40°C	
Operation and storage temperature at max. 95% relative humidity, without condensation	-30°C to +70°C	
Power supply	3,6 V lithium battery / 35 Ah, life span > 5 years	
Weight without battery	GU 192 V2: 310 g GU 192t V2: 350 g	
CE conformity	EN 61000-6-3, emission EN 50121-4, emission (increased requirements for railways)	
Accessories		
Cascading cable COM 100 for connection of a BU 192 movement, length 1 m		Art. no. 116022
Lithium battery, 3,6 V / 35 Ah		Art. no. 106895
Interface IF 494 for connection of a PC over a serial interface RS 232 and for programming of a specific time zone entry		Art. no. 117907
Time set kit: Time set utilities incl. PC tool for time and time zone settings		Art. no. 108165